

MODEL: NF-8209

Your excellent helper in cable test!

Network Cable Tester

INSTRUCTION MANUAL



Your excellent helper in cable test!



VER: V2



Read the precautions before your operation

- Please do not place the device in a location that is dusty, humid, or hot (above 40°C).
- Please use a battery that meets the specifications, otherwise the device may be damaged.
- Please do not disassemble the device. Repair and maintenance should be done by a professional staff.
- When not using the device for a long time, please remove the battery inside the test terminal to prevent the battery liquid from leaking out.
- Please do not use this device to detect live power lines (such as 220V power supply lines), the device may be damaged and personal safety may be influenced.
- Please do not perform related operations on the communication line during thunderstorms to prevent lightning strikes and personal safety.

Table of Contents

Overview.....	01
Keypard display and features.....	01
Product Operation.....	03
1.Continuity testing.....	03
2.Length measurement.....	05
3.Cable scan.....	05
4.PoE testing.....	06
5.Port Flash & Switch details testing.....	07
6.Setting.....	08
7.Specification.....	09
8.Accessories.....	10
9.FAQ.....	11
Diagram of Series Products.....	12

Overview

NF-8209 is a new generation to offer digital and analog signaling all in one network toner and probe. It has three modes for options to track cable like digital mode, analog mode and PoE mode. That means it's equipped with the most powerful cable location technologies for any work environment. Also, it includes cable length measurement, cable faults testing, PoE testing, hub blink and NCV function, all these makes it a must-tool for cabling engineers.

Keypad display and features

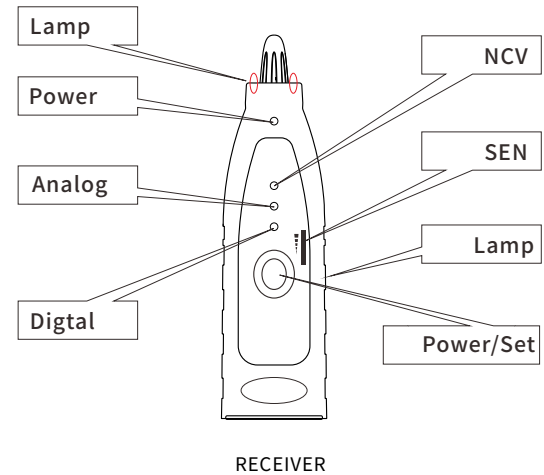
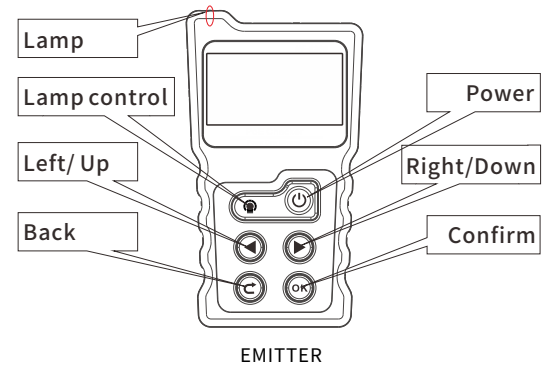
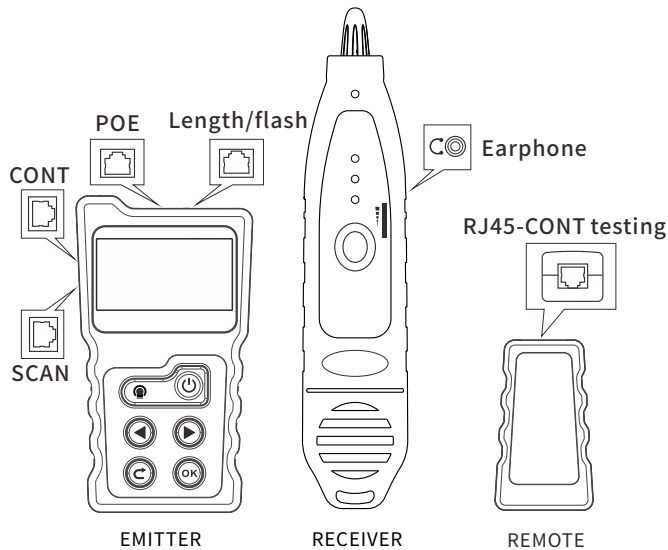

Product Operation

Turn on the device and enter the below main Menu

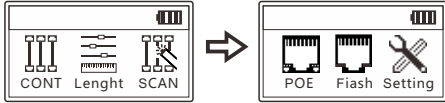

1. CONT-- Test open, short, cross, ect for STP, UTP cable.
2. Length--measure length of lan cable, range is 2.5m~200m.
3. Scan--Analog/Digital/ PoE mode to locate lan cables.
4. PoE-- available for standard or non-standard PoE switch (5~60V), identify AT or AF standard of PSE type.
5. Flash--locate network port by the flashing port light on switch/ router.
6. Setting—Set Language, backlight time, auto-off time, contrast and version.

1. Continuity testing

Connect one end of cable to “CONT” port of tranmister on the left side, the other end to the RJ45 port of remote, Press “OK” to start testing.

If the cable is a good one, the result will be as below.

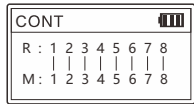

(UTP lan cable)

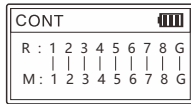

(STP lan cable)

1.1 Possible results

Only if a cable exsits short circuit, no matter it exsits cross, breakage or not,the testing result will only display “Short” information. If it doesn't exsit short circuit, then it would display what actually it is.

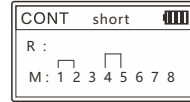

(Pin12, Pin45 are both shorted)

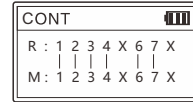

(Pin5 & Pin8 are broken)

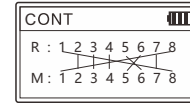

(Pin56, Pin18 are cross)

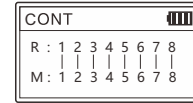

(Good condition)

1.2 Cable Open

If the LCD screen display “Cable Open!”, there are several reasons for this.

1. all the pins are open indeed.
2. no cable is connected.
3. the remote is not connected.
4. Connect with wrong port.

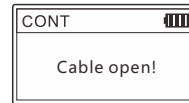

2. Length measurement

Connect one end of cable to “Length/Port flash” port, disconnect the cable at far end, choose “Length” on the main menu, and select the preferred unit (meter/ yard/ foot) before testing.

then press start to measure and the result will come out soon on the screen.

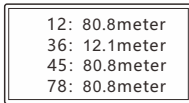

From the image, it means there exists problem at 12.1m. To make sure it is short or broke there, you can test its continuity to know details.

Kind reminds when measuring cable length.

1. the lan cable to be tested must be de-energized.
2. disconnect the cable at the far end, no remote, no other devices connected!
3. The range must be 2.5m~200m, otherwise, it would be display 0 meter.

3. Cable scan

Connect the cable to be tested to “SCAN” port of transmitter on the left side, enter “SCAN” on the main menu, press ok to choose scan mode you prefer, the default is digital mode, the other modes is Analog & PoE. then set the corresponding

mode on receiver accordingly. After that, hold the receiver to locate cable at the other end, the loudest voice is the correct one.

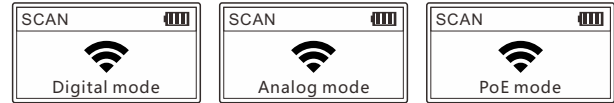

3.1. Attention: If the transmitter is in PoE scan and digital scan mode, the receiver must be in digital mode. the analog scan in transmitter matches analog mode in receiver. If the modes are not matched correctly, even the receiver touch the correct cable, it won't generate tone, either.

3.2. Non-contact voltage detecting: press the “Power/Set” button on the receiver, if the “NCV” indicator is lit on, then you can use the receiver to detect AC voltage presence.

4. PoE Testing

4.1 Standard PoE device

It can test the information of standard PoE device, such as POE voltage, power supply polarity, power supply mode and also the type of PSE(af or at standard).

Connect the cable into “PoE” port, the testing result display as below image.

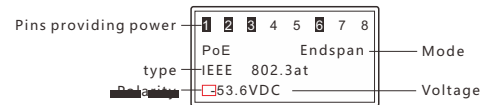

4.2 Non-standard PoE device

If the PoE device is non-standard, it can also test POE voltage, power supply polarity, power supply mode, but it can't tell the type of PSE, just display "Non standard". Connect the cable into "PoE" port, the testing result display as below image.

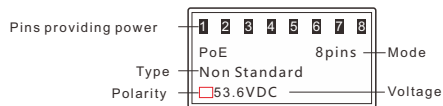

Attention: If all the 8 pins are providing power, it won't display polarity.

4.3 If connected with PoE device, the result can be displayed after a few secs, if there is no result displayed after 30secs, then the device connected may not be PoE device.

5. Port Flash & Switch details testing

Connect a lan cable to "Length/Flash" port on the main unit, choose "Flash" on the main menu to start testing. The 2 indicators on the "Length / Flash" port will be lit and flash. Then observe the ports on switch, if there is a port whose flash frequency is 3 secs, and slower than all the other ports, it tells you the port is the target one you're looking for.

Also, the device can tell you the connected switch's information, such as its speed (10M/100M/1000M), transmitting modes (FDX: full duplex / HDX: half duplex) Protocol (Auto-Nego / Non-Auto-Nego). See the graph for ref. as below.

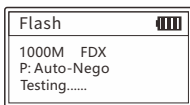

6. Setting

6.1. Backlight setting

Adjust the backlight time among 15s, 30s, 60s, on, and off.

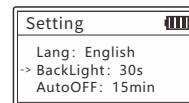

6.2. Auto-off time

adjust the backlight time among 15mins, 30mins, 1h, OFF.

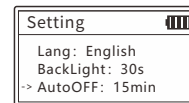

6.3. Contrast setting

Press the left and right keys to adjust the contrast to suit yourself.



6.5. Version information

To check version information of software and hardware .



7. Specification

EMITTER	Wiremap	Cable type	CAT5e, CAT6, CAT6a (STP & UTP)
		Test with switch directly	Yes
		Max range	600m
	Length	Cable type	CAT5e, CAT6, CAT6a (STP & UTP)
		Test range	2.5~200m
		Accuracy	±1.6m
		Breakage location	Yes
	Scan	Cable type	CAT5e, CAT6, CAT6a (STP & UTP)
		Max. signal voltage	9±1Vp-p
		Frequency	130KHz
		Analog / Digital mode	Yes
		Max range	600m
	POE	Test range	DC 5~60V standard / non-standard PoE switch
		Voltage display	Yes
		PSE type	Standard : IEEE 802.3af/at ; Non standard

EMITTER	LCD display	128*64 Dot-matrix with backlight
	Power supply	AAA battery *3
	Low battery warning	2.7V
	Auto-off time	15min/ 30min/ 60min/ OFF
	Voltage protection	DC48V 5mA
	Max working current	<150mA
	Size	130*70*28mm
RECEIVER	Sensitivity adjustable	Yes
	AC Voltage detecting	Yes
	Lamp	Yes
	Battery type	9V* 1pc
	Low battery warning	6± 0.5V
	Max working current	<100mA
Size	210*43*27mm	
REMOTE	Wiremap Port	RJ45
	Voltage protection	DC48V 5mA
	Size	65*37*23mm

8. Accessories

Emitter	1pc	Earphone	1pc
Receiver	1pc	Cable adaptors	1 set
Remote	1pc	Carry bag	1pc
User manual	1pc	Quality certificate	1pc

9.FAQ

Result	Reason or solution
Different testing results for one same cable	Check whether the cable ends are connected well
	Keeps the ports clean
Length measured 0.0m	Connects to wrong port, "Length/Flash" is the correct one.
	Make sure the tested cable length is 2.5m~200m
No results display when test PoE	Connects to wrong port, "PoE" is the correct one
	Test the cable's continuity to make sure it is a good cable
No flashing port when use port flash	Check the PoE device is power on
	Connects to wrong port, "Length/Flash" is the correct one
No tone when track cable	Test the cable's continuity to make sure it is a good cable
	Check the router or switch is on
	Connects to wrong port, "SCAN" is the correct one
No tone when track cable	The mode of transmitter and receiver must keep the same
	Check whether the battery is low
	Turn up the sensitivity
The text on screen is blurry	Adjust the contrast to suit yourself
Turn on the device and auto-off soon	Replace a new battery

Diagram of Series Products



NF-8601S



NF-309



NF-198



NF-511



NF-2030



NF-488



NF-858C



NF-911



NF-707



NF-711F



NF-5120

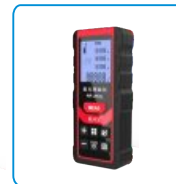

NF-272L